

Efficiency und reliability in Coal Grinding

Economic coal preparation process for low rank coals

Lösungen Ing. Büro FTT
mit Loesche - Mühlen

Dr.-Ing.W.Garber

Prognose für mittlere Kohlepreise, EUR /Tonne

Fazit: **Steigerung der Anwendung von LR-Coals**

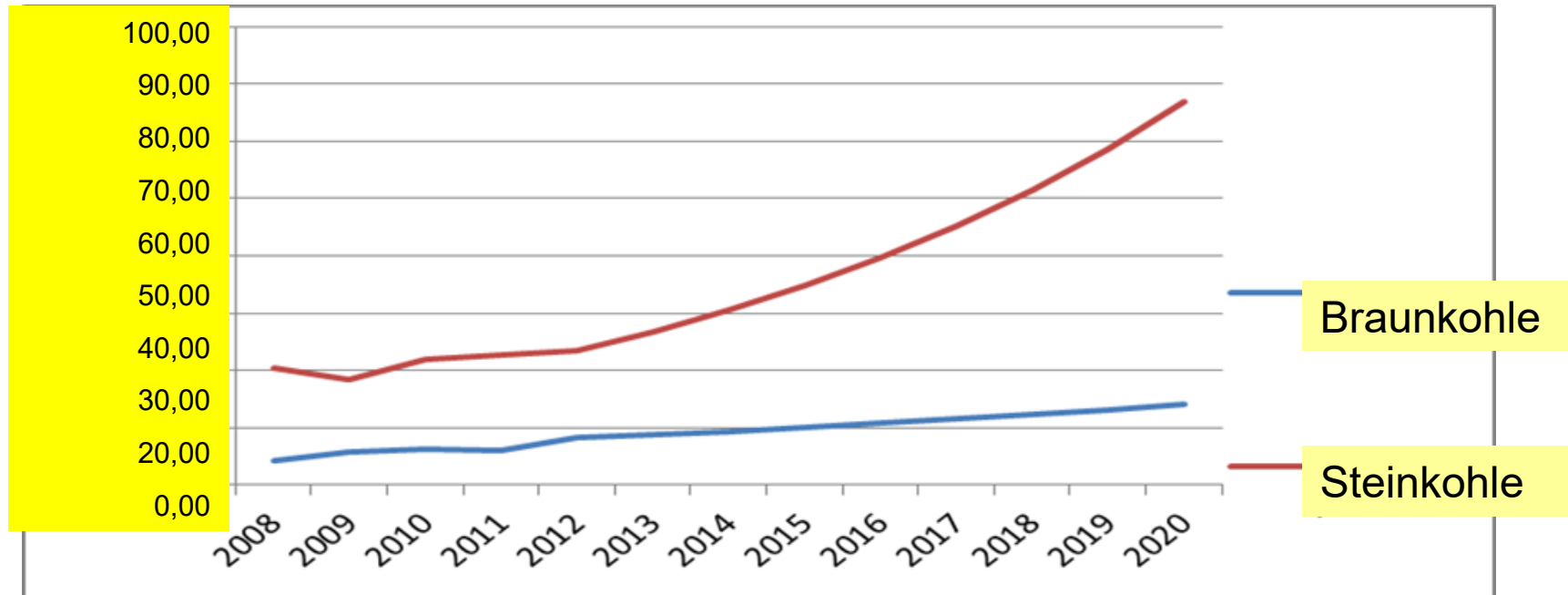
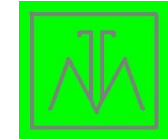

Preisdynamik bis 2020 basierend:

- für Braunkohle gemäß erwartetem Inflationsniveau;
- für Steinkohle gemäß erwarteter Preissteigerung für Erdgas.

Preis-Prognose berechnet gemäß Richtlinien КД ГД

Was können/ wissen Konkurrenten, z.B. Fa. Claudius Peters

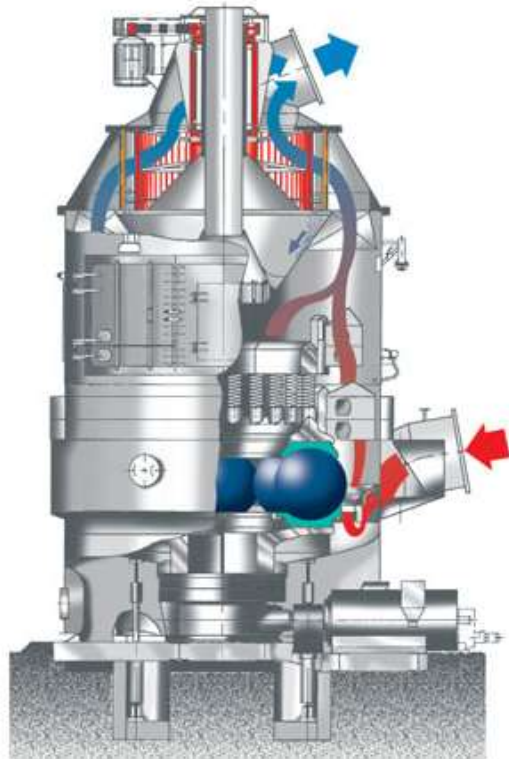

EM110-7115 with dynamic classifier

- Processing of hard, bituminous and lignite coals, other fossil fuels and minerals
- Up to 25% moisture content in the raw material
- Fineness between 1% and 50% residue on 0,09 mm

The characteristic features of EM-Mills are:

- Minimal sound emissions
- High productivity
- Low maintenance requirements
- Self adjusting hydraulic tensioning unit
- Mill inlet temperature up to 650 °C / 1200 °F
- No material remaining inside the mill during standstill

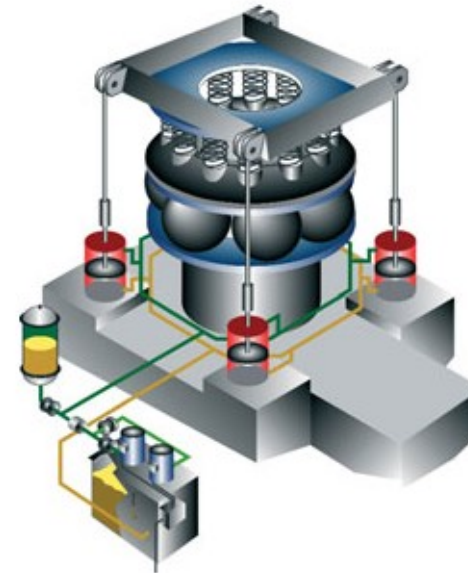
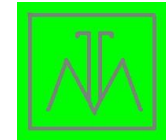

Shock-absorbing, self-adjusting hydraulic system: Pressure and wear optimization for low energy consumption.

Was können/ wissen Konkurrenten, z.B. Fa. Claudius Peters

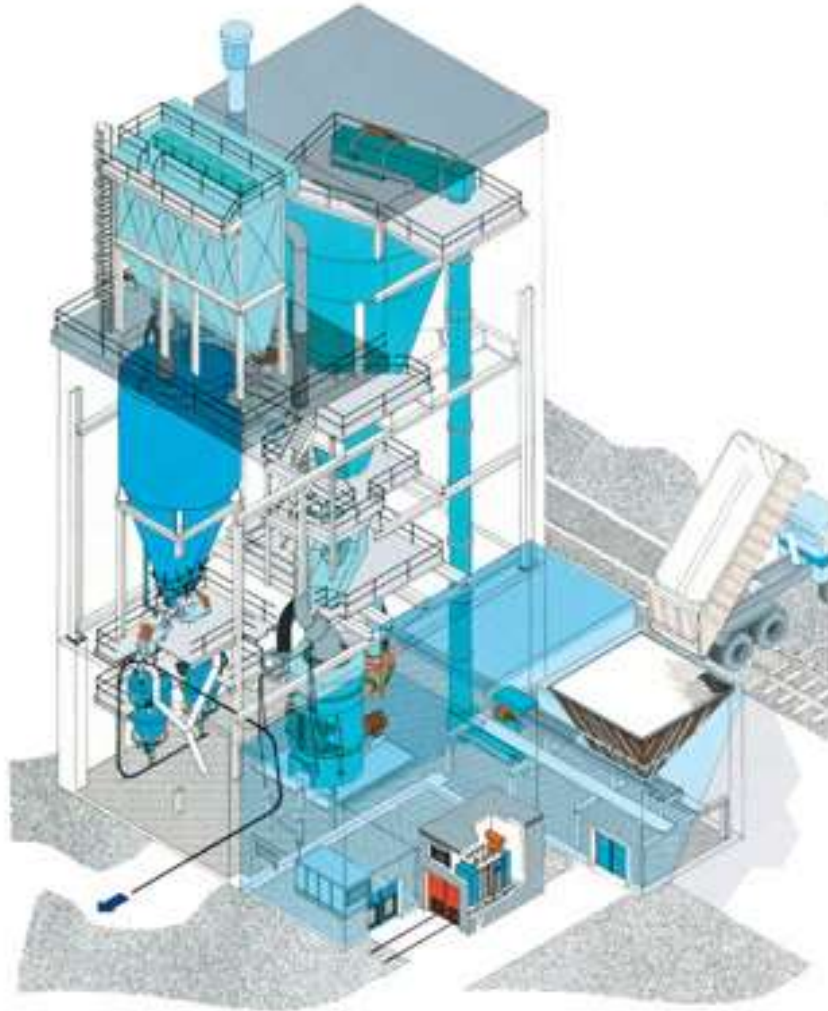
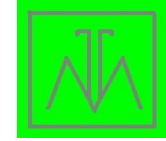

Coal Milling, Drying and Injection Plant for a Blast Furnace

Safety

Claudius Peters grinding plant can operate under a variety of safety criteria.

In the safest process, inert operation, the oxygen level is lowered to less than 10% under all operating conditions. All values of O_2 and CO are continuously monitored and optimized automatically, thereby preventing dust explosions.

Alternatively when inert operation is not possible, for instance in power station service, the pressure shock resistant mill design (up to 3.5 bar g) guarantees the highest possible operational safety.

Claudius Peters hat eine Versuchsanlage mit dem Flash Dryer

Due to the high moisture content of so called "low rank coals (moisture content up to 60%)" the requested residual moisture will be achieved in a two-step drying system only. Prior to the coal milling and drying plant a raw coal pre drying plant will be installed.

- In a first step the pre-crushed coal (< 25 mm) will be dried to approximately 20% moisture using higher temperatures than allowed for pulverized coal at a reasonable airflow and a low pressure drop
- In a second step the coal will be ground to the requested fineness and dried from about 20 % moisture to the required residual moisture at the maximum allowed temperature for pulverized coals

Combination of the two steps is the most economical and safe solution for the design of coal preparation plants for low rank coals.

Lösung von Claudius Peters

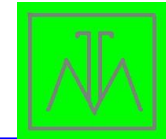

Leistung Braunkohlestaub 50-60 T/h
 Rohkohle Wassergehalt 30-40%
 BKS 1-50%R90 mkm.

separate komplette Trocknungsanlage
separate komplette Trocknung- Mahlanlage

Preis Mahlanlage €
 Preis Trocknungsanlage €
 insgesamt: €

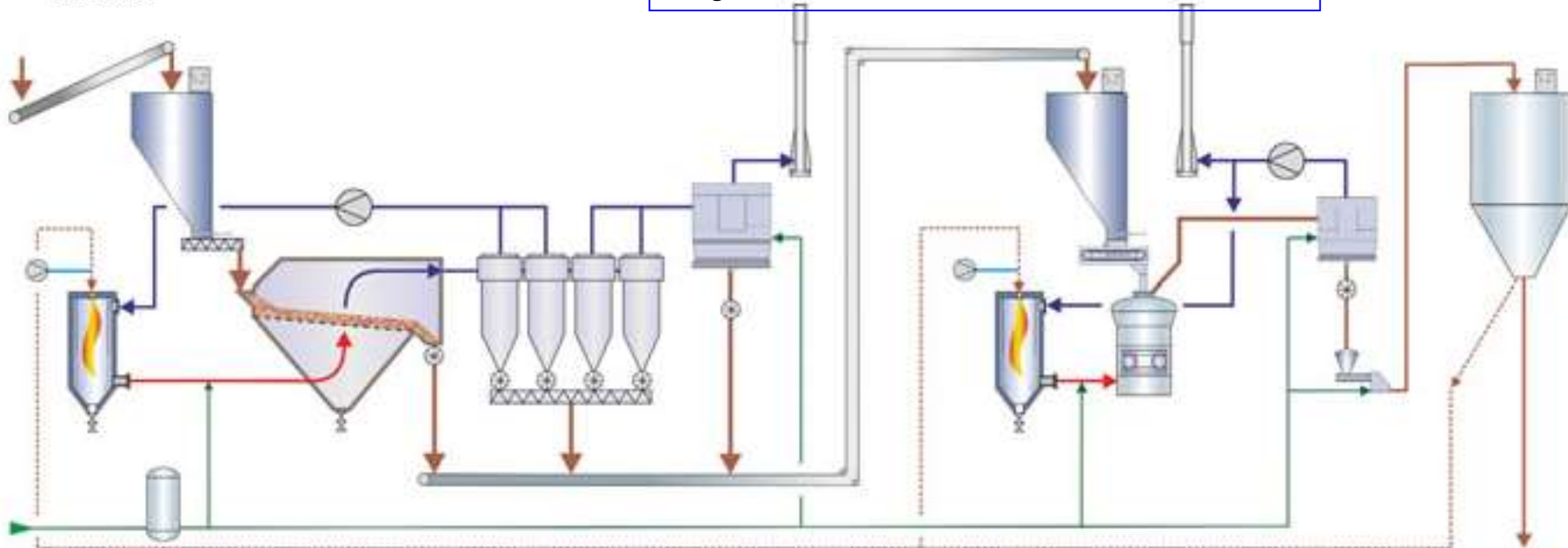

Flow diagram of Coal Preparation Plant

Verfahrens-technische Mühleoptimierung

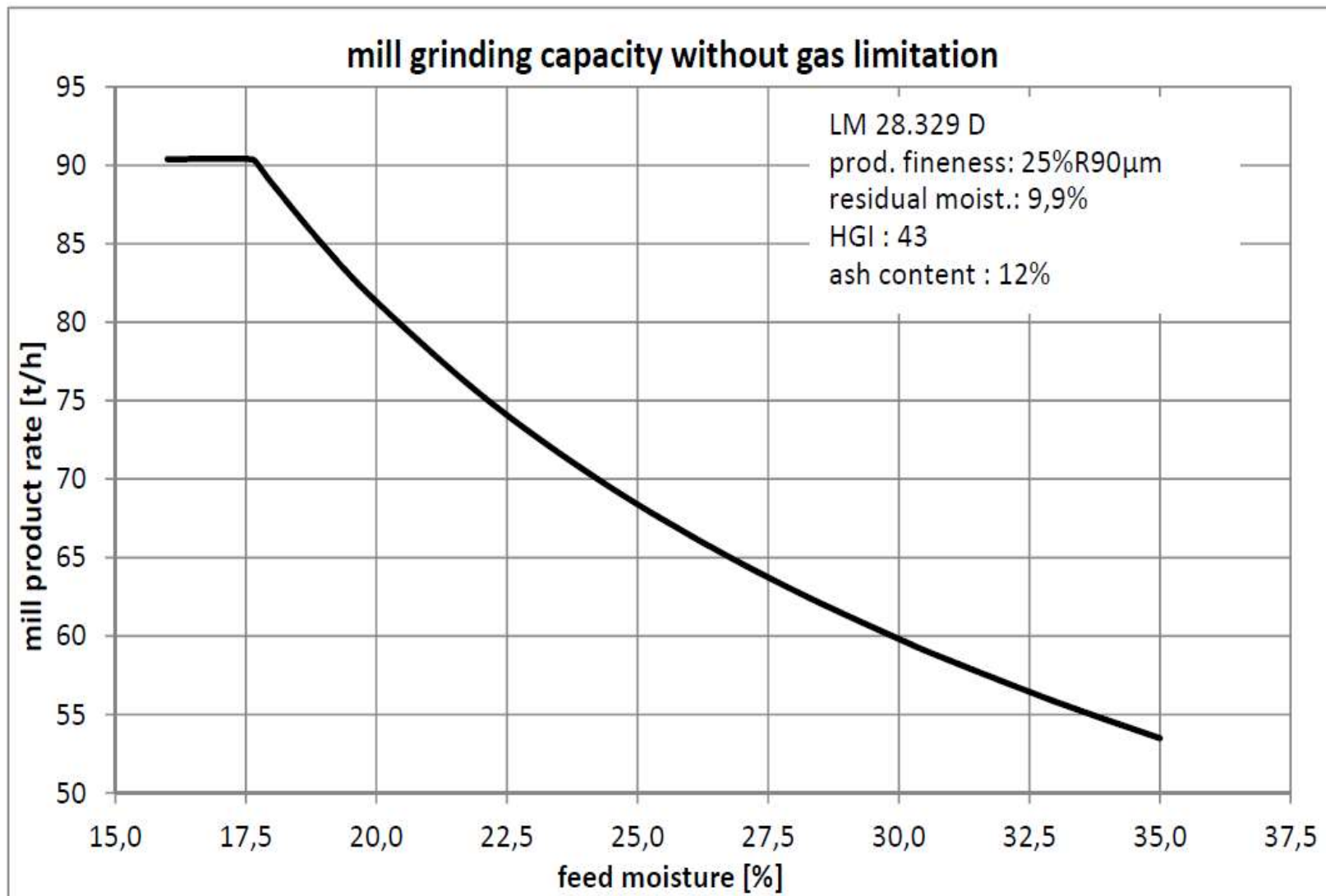

Leistung- Steigerung durch Heißgastemperaturen



Verfahren	Mühle Leistung	Heißgas Temperatur	Abgas Menge	HGG Leistung
	t/h	°C	m3/h	MW
1.	50	700	172.536	22,57
2.	60	700	207.042	27,07
3.	60	800	184.073	26,52
4.	60	900	166.787	26,11
5.	70	900	194.585	30,46
6.	70	1000	178.864	30,07
7.	70	1100	166.267	29,77

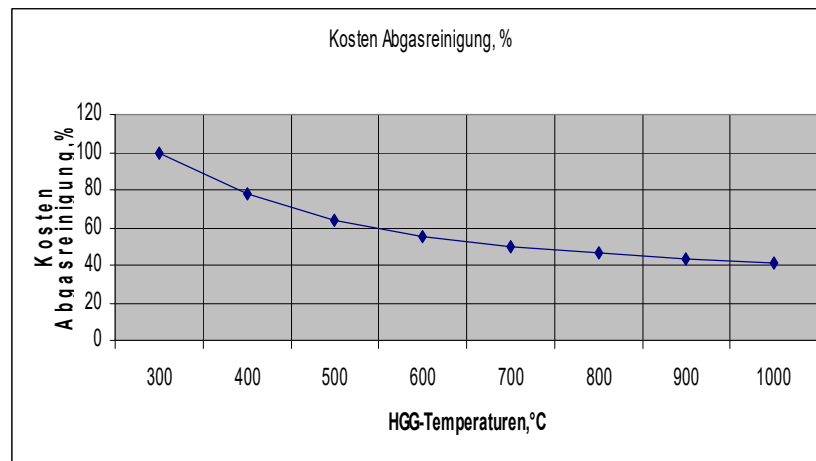
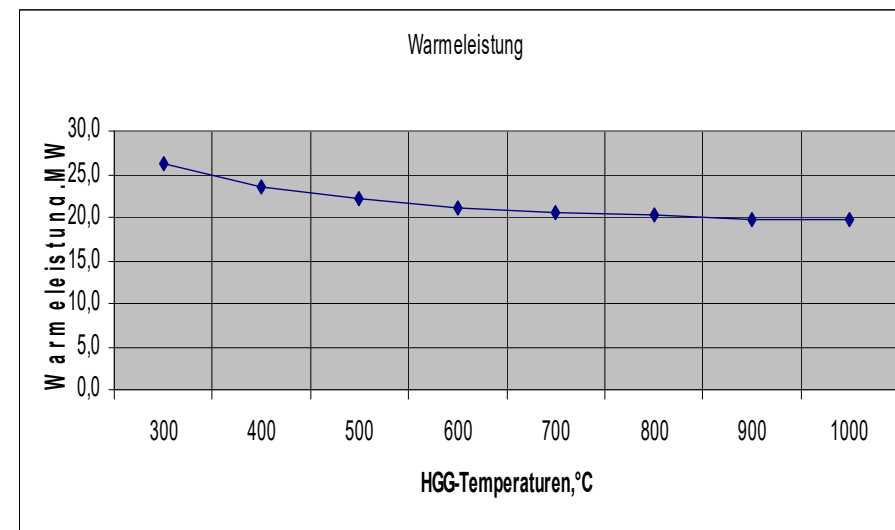
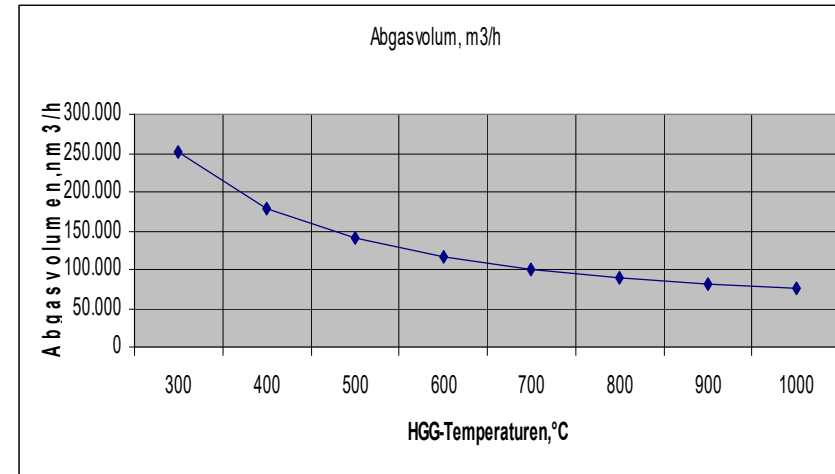

**Abhängigkeit Anlageparameter von Heißgastemperatur,
Beispiel Kohle Trocknung- Vermahlung bei W1=35%, W2= 9%**

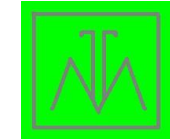

Heißgastemperatur	°C	300	400	500	600	700	800	1000
Abgase nach Trocknung	Nm3/h	250.000	180.000	140.000	120.000	100.000	90.000	75.000
Wärme-Leistung	MW	26,3	23,5	22,1	21,2	20,6	20,2	19,6
Brennstoff Bedarf	Kg/h	4030	3600	3380	3240	3150	3090	3000
Preis Schlauchfilter	EUR	580.000	459.360	373.520	334.080	290.000	271.440	243.600
Preisdifferenz Schlauchfilter	EUR		120.640	206.480	245.920	290.000	308.560	336.400
Kosten Abgasreinigung	%	100	79	64	58	50	47	42

Lösung Loesche for Low Rank Coal Grinding

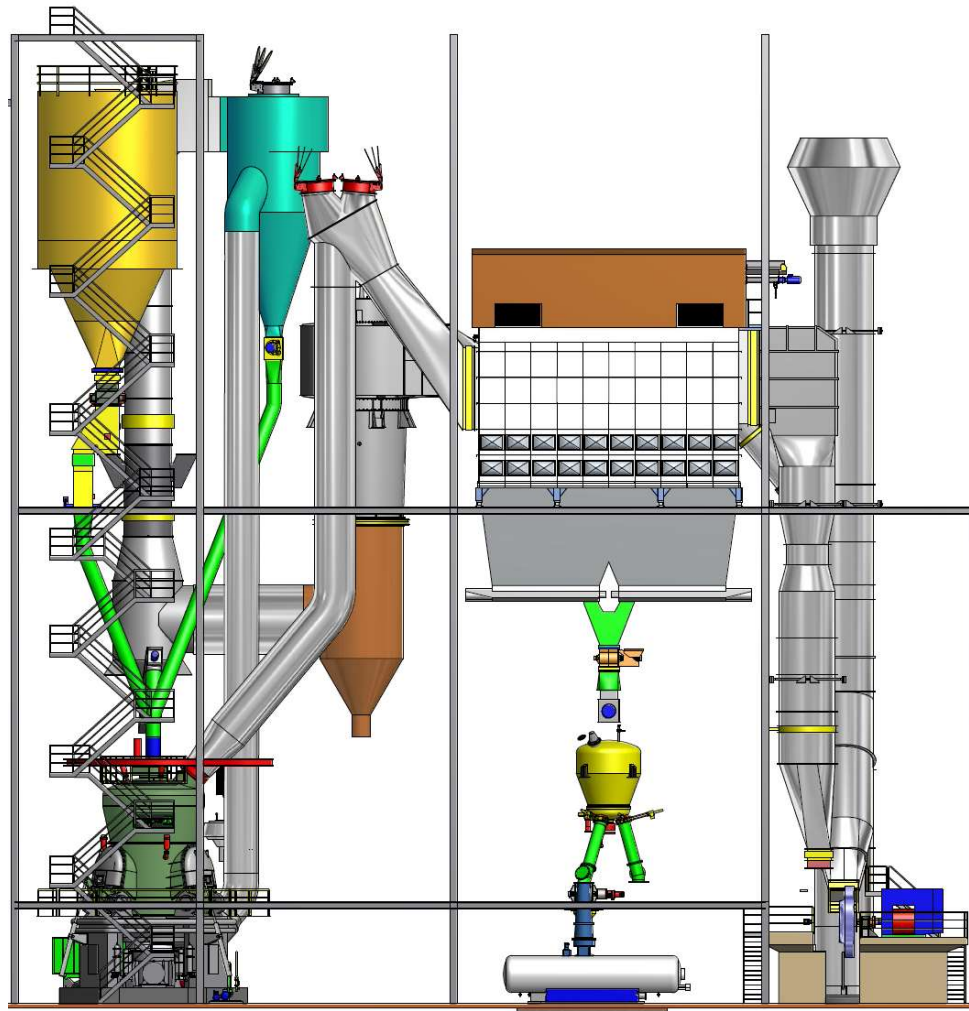
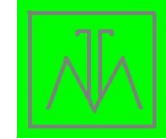

Vorgeschaltete SRT- Vortrockner
mit gemeinsamen Heizgaserzeuger,
Abgasreinigung, Hauptgebläse und Kamin
Heißgastemperaturen bis zum 1000°C

Leistung Braunkohlestaub 60-75 T/h
Rohkohle Wassergehalt 30-40%
Vorzerkleinerung bis ca. 10-20 mm.
BKS 10-60%R90 mkm.

Preis Mahlanlage €
integrierte Trocknungsanlage €
Insgesamt €

Kunde Atschinsk- Glinozem RussALL
Pilot Anlage LM28.3D Jahr 2014
Weitere 4 Anlagen Jahr 2017

Vertriebsgebiete
Russland, Kasachstan, China, Indien,
Indonesien, Australien, USA, Europa,

BKS- Selbsterzündung und Kohlestaubkühler

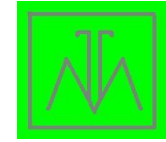

Fazit IBEXU:

ohne Kohlestaubkühler keine Braunkohlevermahlung mit Silo-Lagerung



Bild 1: 350 m³-Silo nach Zeichnung Nr. AC 032 0101

Low rank Kohle	Temperatur nach der Mühle, °C	Selbsterzündung Temperatur in 1 m ³ , °C
Borodinskij Braunkohle	100-90	52,3
Berezovskij Kohle	100-90	52,5

Sättigungspunkt in Abgasen

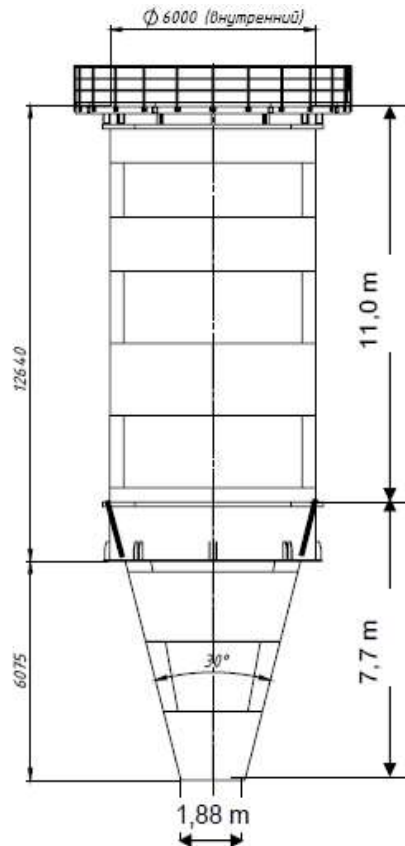
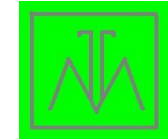

Bedingungen in Atschinsk:

Taupunkt 68-73°C

Lufttemperatur in Sommer = 26°C

Lufttemperatur in Winter = bis zum minus 48°C

Sättigungspunkt in Abgasen bei
Heißgasen 300- 700 °C

Lufttransport

Luftzusatz zur Verdünnung	m3	0	135,71	235,71	535,71	935,71	1935,71	3935,71
Luftmenge zwischen Partikeln von Kohlestaub	m3/kg.Kohle- Staub	0,00129						
Gesamt Luftmenge in 50 Tonne Kohlestaub	m3	64,29	200	300	600	1000	2000	4000
Wassermenge in Luft-Abgasen nach der Trocknung	kg/m3	0,37	0,37	0,37	0,37	0,37	0,37	0,37
Gesamt Wassermenge in Luft mit 50 T Kohlstaub	kg	23,79	23,79	23,79	23,79	23,79	23,79	23,79
Gehalt Wasser in Recyclung Abgasen	kg/kg	0,29	0,09	0,06	0,03	0,02	0,01	0,005
Taupunkt	°C	68	51	42	30	20	10	<5

KS-Kühler von Allgaier / Claudius Peters Roraty Drum Cooler

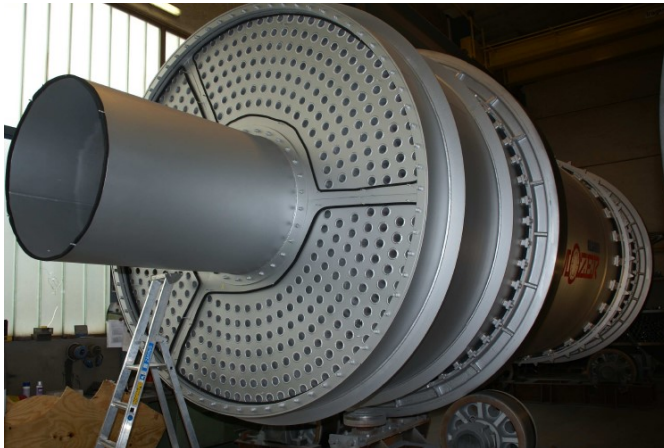
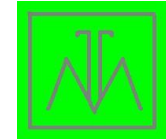

Indirekte Luftkühler Kohlestaubkühler
60 T/h BKS
Staub – 100°C, Luft – 25°C
Abmessungen: Trommel 3 x 12 m
Verdünnung – Luft ca. 4000 m³/h

Preis: Ex- Work 850.000 €
Optionen: 150.000 €
insgesamt: ca. 1.000.000 €

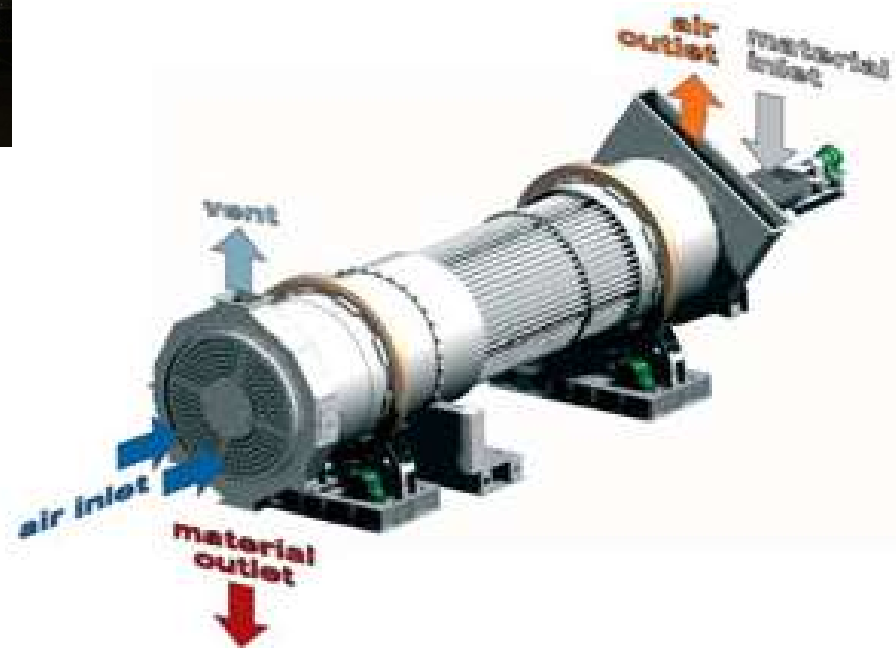

Strömungs-Kohlestaub-Kühler FTT- Loesche

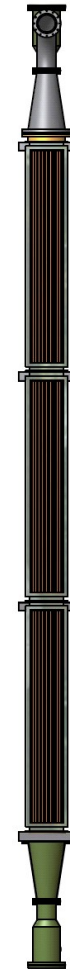
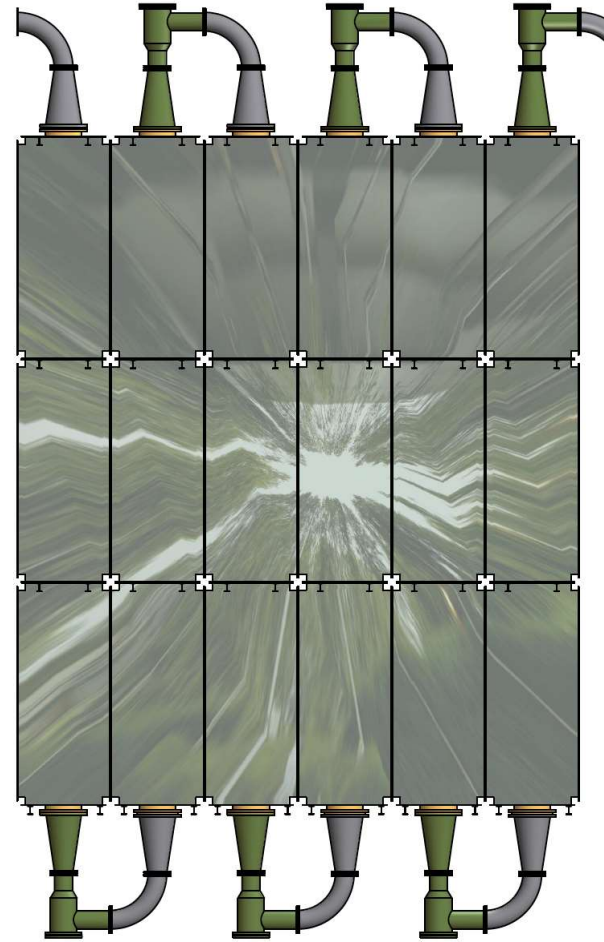
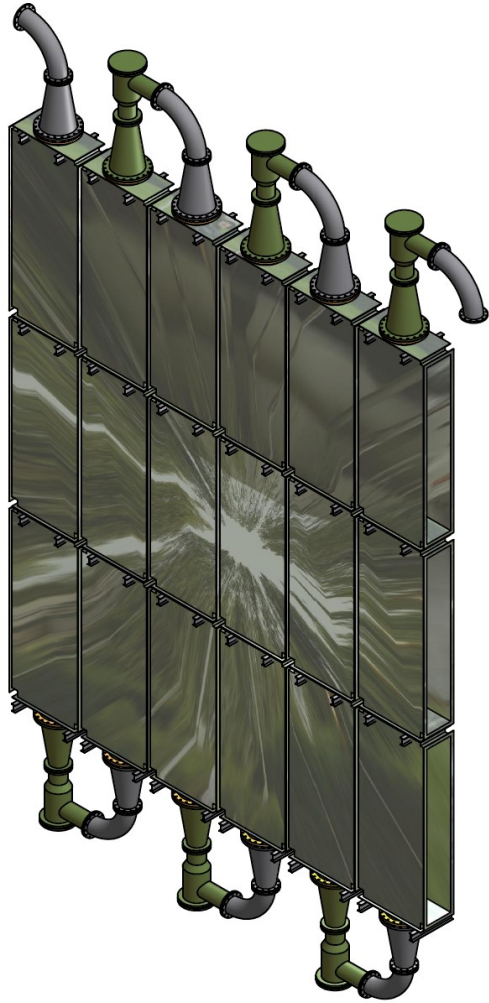
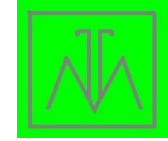

Strömungs-Kohlestaub-Kühler FTT- Loesche, Sektion und Übergänge

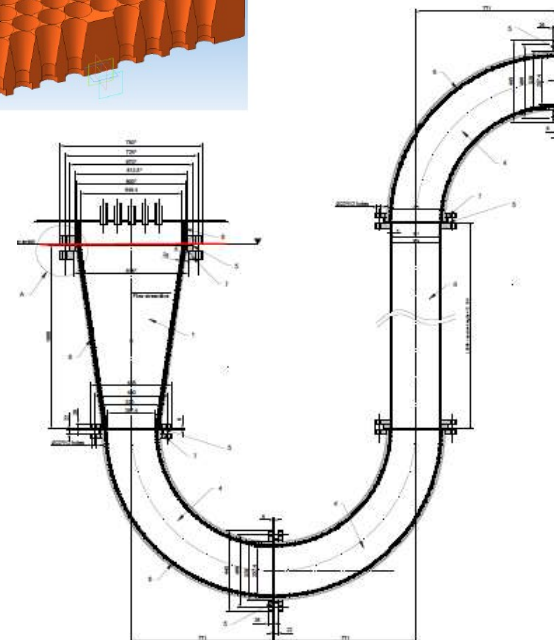
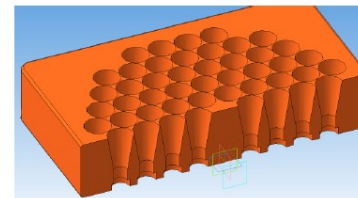
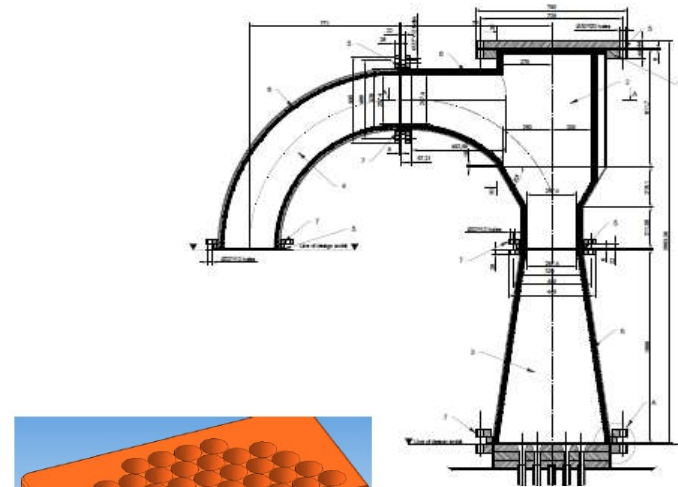
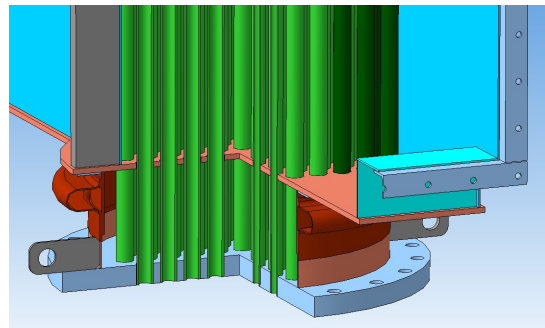
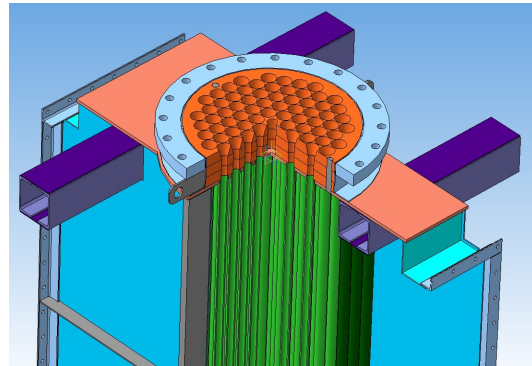
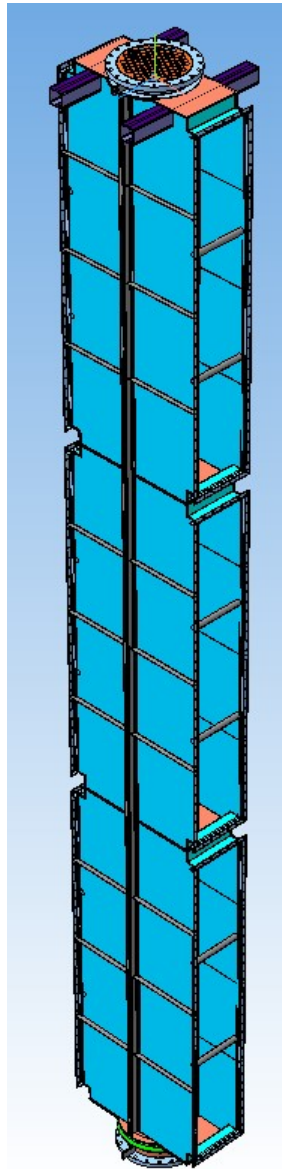
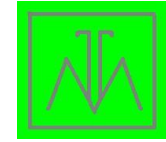

Strömungs-Kohlestaub-Kühler FTT - Loesche

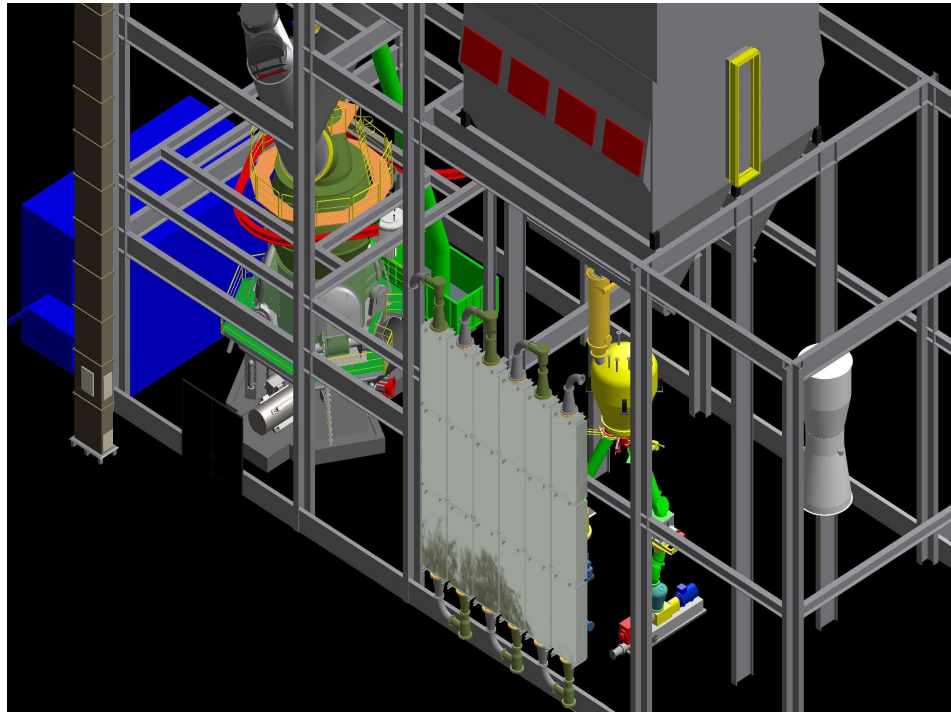
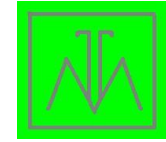

Vertriebsgebiete

Russland, Kasachstan, China, Indien,
Indonesien, Australien, USA, Europa,

Indirekte Luftkühler Kohlestaubkühler

50 - 70 T/h BKS, KS, Holzstaub usw.
Kühlt Staub – von 100°C bis zum 50°C

Abmessungen: 6 Sektion- Paket

B 0,5m x H13 m x L 9,2m

Verdünnung – Druck-Luft ca. 4167 kg/h

Wärmerückgewinnung ca. 0,75 MW

Preis: Ex- Work 350.000 €

Optionen: 150.000 €

insgesamt: ca. 500.000 €

Anwendungen:

Kühlung nach Vermahlung

Braunkohlestaub,

Steinkohlestaub,

Holz Kohlestaub,

Zementstaub,

sonstige Pulver

bzw. Pulver - Erhitzung